

**Industrial L2/L4 Managed Gigabit Switch
with 4-/8-/16-Port 802.3at PoE+**

**IGS-4215-4P4T/IGS-4215-4P4T2S
IGS-4215-8P2T2S/IGS-4215-16P2T2S**

**Industrial L2/L4 Managed Gigabit Switch
with 4-/8-Port 802.3bt PoE++**

IGS-4215-4UP4T2S/IGS-4215-8UP2T2S

Quick Installation Guide

Table of Contents

1. Package Contents	3
2. Requirements	4
3. Wiring the Power Inputs.....	5
3.1 Grounding the Device.....	7
4. Terminal Setup	8
4.1 Logging on to the Console	9
4.2 Configuring IP Address via Console	11
4.3 Storing Current Switch Configuration	12
5. Starting Web Management.....	13
5.1 Logging in to the Industrial Managed PoE+ Switch	13
5.2 Saving Configuration via Web	17
6. Recovering Back to Default Configuration.....	18
7. Customer Support	19

1. Package Contents

Thank you for purchasing PLANET L2/L4 Managed Gigabit Switch. The descriptions of these models are shown below:

IGS-4215-4P4T	Industrial 4-Port 10/100/1000T 802.3at PoE + 4-Port 10/100/1000T Managed Switch
IGS-4215-4P4T2S	Industrial 4-Port 10/100/1000T 802.3at PoE + 4-Port 10/100/1000T + 2-Port 100/1000X SFP Managed Switch
IGS-4215-8P2T2S	Industrial 8-Port 10/100/1000T 802.3at PoE + 2-Port 10/100/1000T + 2-Port 100/1000X SFP Managed Switch
IGS-4215-16P2T2S	Industrial 16-Port 10/100/1000T 802.3at PoE + 2-Port 10/100/1000T + 2-Port 100/1000X SFP Managed Switch
IGS-4215-4UP4T2S	Industrial 4-Port 10/100/1000T 802.3bt PoE + 4-Port 10/100/1000T + 2-Port 100/1000X SFP Managed Switch
IGS-4215-8UP2T2S	Industrial 8-Port 10/100/1000T 802.3bt PoE + 2-Port 10/100/1000T + 2-Port 100/1000X SFP Managed Switch

“**Industrial Managed PoE+ Switch**” is used as an alternative name in this Quick Installation Guide.

Open the box of the Industrial Managed PoE+ Switch and carefully unpack it. The box should contain the following items:

- The Industrial Managed PoE+ Switch x 1
- QR Code Sheet x 1
- RS232 to RJ45 Console Cable x 1
- Dust Caps

Model	RJ45 Dust Caps	SFP Dust Caps
IGS-4215-4P4T	9	-
IGS-4215-4P4T2S	9	2
IGS-4215-8P2T2S	11	2
IGS-4215-16P2T2S	19	2
IGS-4215-4UP4T2S	9	2
IGS-4215-8UP2T2S	11	2

- DIN-rail Kit x 1
- Wall Mounting Kit x 1

If any item is found missing or damaged, please contact your local reseller for replacement.

2. Requirements

- ◆ **Workstations** running Windows 7/8/10/11, macOS 10.12 or later, Linux Kernel 2.6.18 or later, or other modern operating systems are compatible with TCP/IP Protocols.
- ◆ Workstations are installed with Ethernet NIC (Network Interface Card)
- ◆ **Serial Port Connection** (Terminal)
 - The above Workstations come with COM Port (DB9) or USB-to-RS232 converter.
 - The above Workstations have been installed with **terminal emulator**, such as Tera Term, PuTTY or Hyper Terminal included in Windows XP/2003.
 - Serial cable -- one end is attached to the RS232 serial port, while the other ends to the RJ45 console port of the Industrial Managed PoE+ Switch.
- ◆ **Ethernet Port Connection**
 - Network cables -- Use standard network (UTP) cables with RJ45 connectors.
 - The above PC is installed with Web browser.



Note

It is recommended to use Google Chrome, Microsoft Edge or Firefox to access the Industrial Managed PoE+ Switch. If the Web interface of the Industrial Managed PoE+ Switch is not accessible, please turn off the anti-virus software or firewall and then try it again.

3. Wiring the Power Inputs

The Upper Panel of the Industrial Managed PoE+ Switch indicates a DC inlet power socket and consists of one terminal block connector within 6 contacts. Please follow the steps below to insert the power wire.

1. Insert positive/negative DC power wires into contacts 1 and 2 for Power 1 or 5 and 6 for Power 2.

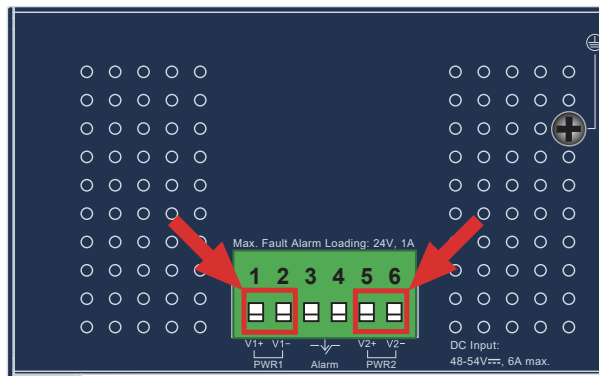

Figure 3-1: IGS-4215-4P4T/IGS-4215-4P4T2S/IGS-4215-8P2T2S DC Inlet Power Socket

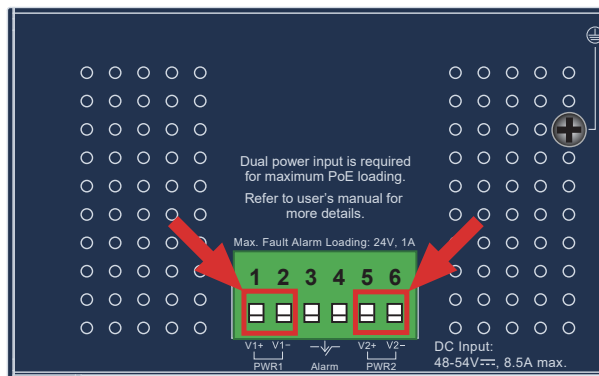

Figure 3-2: IGS-4215-4UP4T2S/IGS-4215-8UP2T2S DC Inlet Power Socket

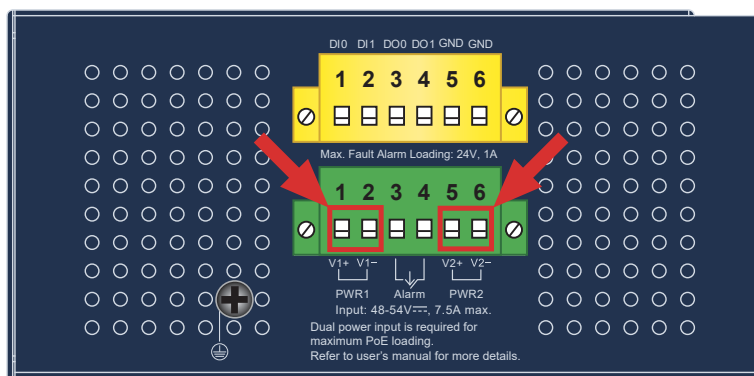

Figure 3-3: IGS-4215-16P2T2S DC Inlet Power Socket

2. Tighten the wire-clamp screws for preventing the wires from loosening.

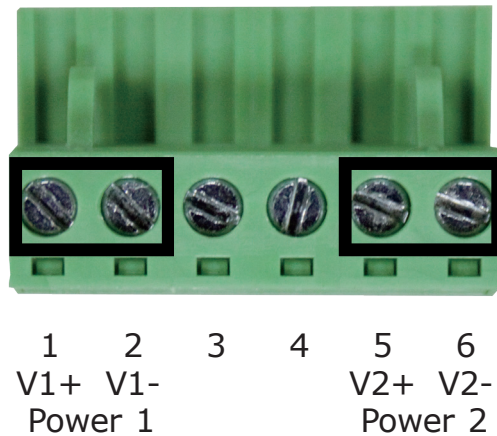

Figure 3-4: Power 1 & 2 Pins of Terminal Block Connector

Item	Positive (+) Pin	Negative (-) Pin
IGS-4215 Series	Pin 1/5	Pin 2/6



Note

1. The wire gauge for the terminal block should be in the range from **12** to **24 AWG**.
2. Please check the wire AWG Ampere specification before connecting PLANET Industrial Managed PoE+ Switch.



Caution

PWR1 and PWR2 must provide exactly the **same DC voltage** for power load balance while operating with dual power input.

3.1 Grounding the Device

Users **MUST** complete grounding wired with the device; otherwise, a sudden lightning could cause fatal damage to the device.

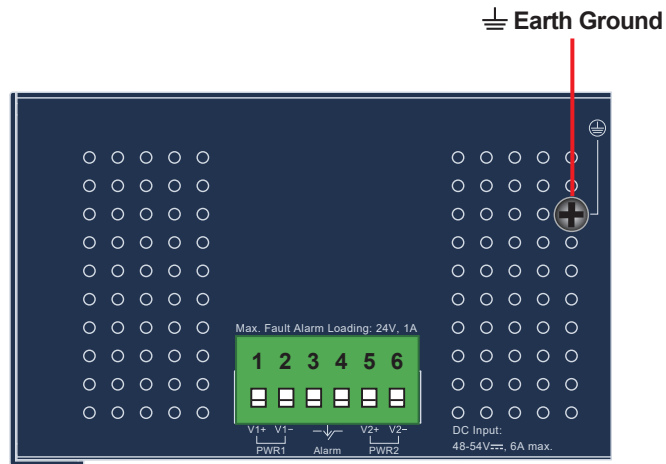

Figure 3-5: Grounding Method (applies to all models)

4. Terminal Setup

To configure the system, connect a serial cable to a **COM port** on a PC or notebook computer and to the RJ45 type of the console port of the Industrial Managed PoE+ Switch.

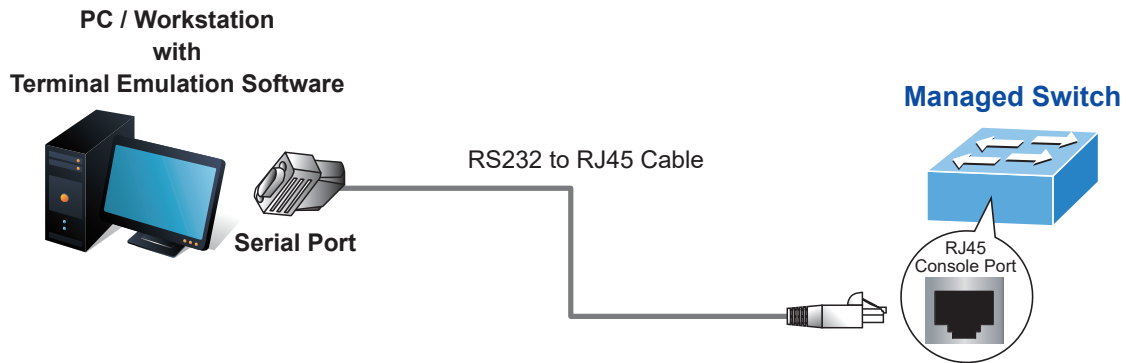

Figure 4-1: Industrial Managed PoE+ Switch Console Connectivity

A terminal program is required to make the software connection to the Industrial Managed PoE+ Switch.

1. Run terminal program on the OS.
2. When the following screen appears, make sure that the COM port should be configured as:
 - ◆ Baud: 115200
 - ◆ Data bits: 8
 - ◆ Parity: None
 - ◆ Stop bits: 1
 - ◆ Flow control: None

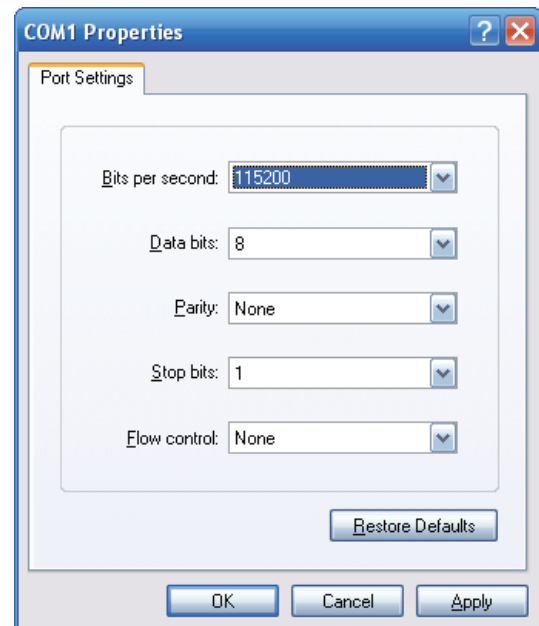

Figure 4-2: COM Port Configuration

4.1 Logging on to the Console

Once the terminal is connected to the device, power on the Industrial Managed PoE+ Switch and the terminal will display “running testing procedures”. Then, the following message asks to log in user name and password. The factory default user name and password are shown as follows, and the login screen in Figure 4-3 appears.



Note

The following console screen is based on the IGS-4215-8P2T2S. The display of the other IGS-4215 PoE Series is the same as that of the IGS-4215-8P2T2S.

Then, the following message asks to log in user name and password. The factory default user name and password are shown as follows as the login screen in Figure 4-1 appears.



Note

The following console screen is based on the firmware version before **February of 2024**.

Username: **admin**

Password: **admin**

```
Press any key to continue
Username: admin
Password: *****
IGS-4215-8P2T2S#
```

Figure 4-3: Industrial Managed PoE+ Switch Console Login Screen

The user can now enter commands to manage the Industrial Managed PoE+ Switch. For a detailed description of the commands, please refer to the following chapters.



Note

1. For security reason, **please change and memorize the new password after this first setup.**
2. Only accept command in lowercase letter under console interface.



Note

The following console screen is based on the firmware version of **February of 2024 or after**.

Username: **admin**

Password: **sw + the last 6 characters of the MAC ID in lowercase**

Find the MAC ID on your device label. The default password is "sw" followed by the last six lowercase characters of the MAC ID.

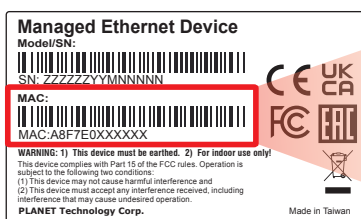

MAC ID: A8F7E0XXXXXX

Default Password: swxxxxxx

("x" means the last 6 digits of the MAC address.

All characters should be in lowercase.)

Figure 4-4: MAC ID Label

Enter the default username and password, then set a new password according to the rule-based prompt and confirm it.

```
(New)Password: *****
Verify (New)Password: *****
Success.
Press any key to continue
Username: admin
Password: *****
IGS-4215-8P2T2S#
```

Figure 4-5: Industrial Managed PoE+ Switch Console Login Screen

The user can now enter commands to manage the Industrial Managed PoE+ Switch. For a detailed description of the commands, please refer to the following chapters.



Note

1. For security reason, please change and memorize the new password after this first setup.
2. Only accept command in lowercase letter under console interface.

4.2 Configuring IP Address via Console

The Industrial Managed PoE+ Switch is shipped with default IP address as follows:

```
IP Address: 192.168.0.100  
Subnet Mask: 255.255.255.0
```

To check the current IP address or modify a new IP address for the Industrial Managed PoE+ Switch, please use the procedures as follows:

■ Show the current IP address

1. At the "**IGS-4215-8P2T2S#**" prompt, enter "**show ip**".
2. The screen displays the current IP address, subnet mask and gateway as shown in Figure 4-6.

```
Press any key to continue  
Username: admin  
Password: *****  
IGS-4215-8P2T2S# show ip  
IP Address: 192.168.0.100  
Subnet Netmask: 255.255.255.0  
Default Gateway: 192.168.0.254  
IGS-4215-8P2T2S#
```

Figure 4-6: IP Information Screen

■ Configuration of the IP Address

3. At the "**IGS-4215-8P2T2S #**" prompt, enter "**configure**".
4. At the "**IGS-4215-8P2T2S (config)#**" prompt, enter the following command and press **<Enter>** as shown in Figure 4-7.

```
IGS-4215-8P2T2S (config)# ip address 192.168.1.100 mask 255.255.255.0  
IGS-4215-8P2T2S (config)# ip default-gateway 192.168.1.254
```

The previous command would apply the following settings for the Industrial Managed PoE+ Switch.

```
IP Address: 192.168.1.100  
Subnet Mask: 255.255.255.0  
Gateway: 192.168.1.254
```

```
Press any key to continue  
Username: admin  
Password: *****  
IGS-4215-8P2T2S# configure  
IGS-4215-8P2T2S(config)# ip address 192.168.1.100 mask 255.255.255.0  
IGS-4215-8P2T2S(config)# ip default-gateway 192.168.1.254  
IGS-4215-8P2T2S(config)#
```

Figure 4-7: IP Address Screen

5. Repeat Step 1 to check if the IP address has changed.

If the IP is successfully configured, the Industrial Managed PoE+ Switch will apply the new IP address setting immediately. You can access the Web interface of the Industrial Managed PoE+ Switch through the new IP address.

4.3 Storing Current Switch Configuration

1. At the **"IGS-4215-8P2T2S#"** prompt, enter **"copy running-config startup-config"** as shown in Figure 4-8.

```
Press any key to continue
Username: admin
Password: *****
IGS-4215-8P2T2S# copy running-config startup-config
Success
IGS-4215-8P2T2S#
```

Figure 4-8: The Configuration Save Screen



Note

If you are not familiar with console command or the related parameter, enter "?" anytime in console to get the help description.

5. Starting Web Management

The following shows how to start up the **Web Management** of the Industrial Managed PoE+ Switch. Note the Industrial Managed PoE+ Switch is configured through an Ethernet connection. Please make sure the manager PC must be set to the same **IP subnet address**.

For example, the default IP address of the Industrial Managed PoE+ Switch is **192.168.0.100**, then the manager PC should be set to **192.168.0.x** (where x is a number between 1 and 254, except 100), and the default subnet mask is 255.255.255.0.

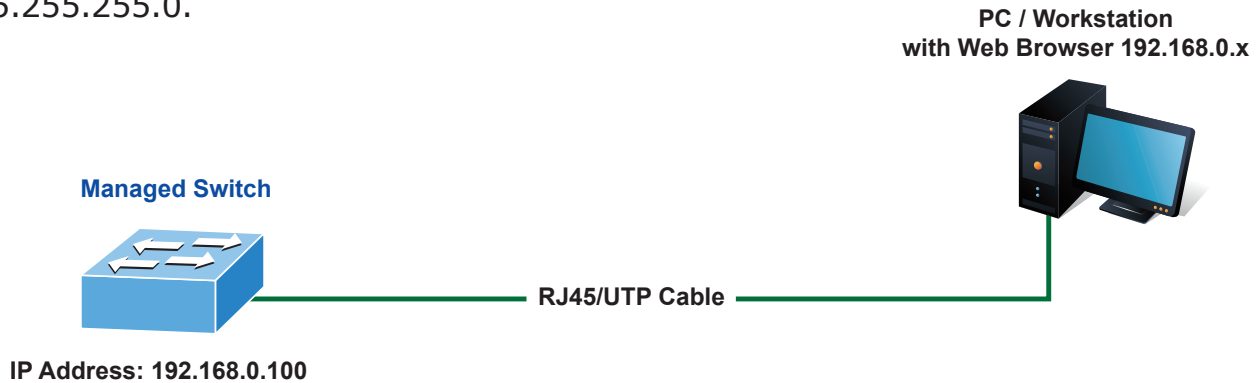

Figure 5-1: IP Management Diagram

5.1 Logging in to the Industrial Managed PoE+ Switch

1. Use Google Chrome or above Web browser and enter IP address **https://192.168.0.100** to access the Web interface.



Note

The following console screen is based on the firmware version before **February of 2024**.

2. When the following dialog box appears, please enter the default user name and password "**admin**". The login screen in Figure 5-2 appears.

Default Username: **admin**
Default Password: **admin**

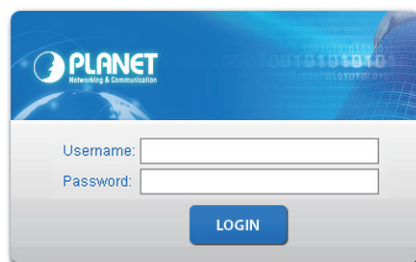



Figure 5-2: Web Login Screen

3. After entering the password, the main screen appears as Figure 5-6 shows.

 Note
The following web screen is based on the IGS-4215-8P2T2S. The display of the other IGS-4215 PoE series is the same as that of the IGS-4215-8P2T2S.

 Note
The following web screen is based on the firmware version of **February of 2024 or after**.

4. When the following dialog box appears, please enter the default user name and password. Refer to **Section 4.1** to determine your initial login password.

Default IP Address: **192.168.0.100**
Default Username: **admin**
Default Password: **sw + the last 6 characters of the MAC ID in lowercase**

5. Find the MAC ID on your device label. The default password is "sw" or "mc" followed by the last six lowercase characters of the MAC ID.

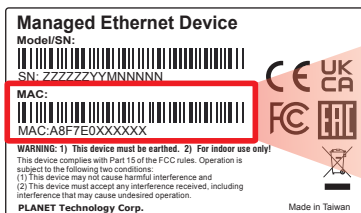

MAC ID: A8F7E0XXXXXX
Default Password: swxxxxxx
("x" means the last 6 digits of the MAC address.
All characters should be in lowercase.)

Figure 5-3: Industrial Managed Switch MAC ID Label

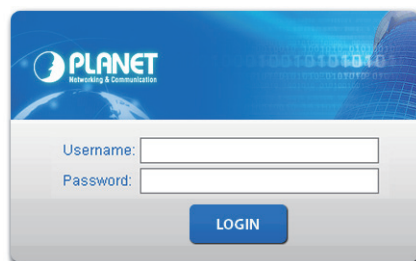
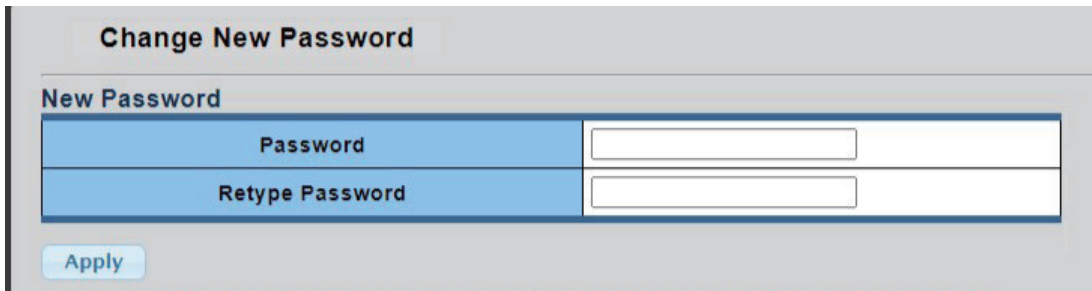

Figure 5-4: Web Login Screen

6. After logging in, you will be prompted to change the initial password to a permanent one.



Change New Password	
New Password	
Password	<input type="text"/>
Retype Password	<input type="text"/>
<input type="button" value="Apply"/>	

Figure 5-5: Create a New Password

7. Enter the default username and password, then set a new password according to the rule-based prompt and confirm it. Upon success, press any key to return to the login prompt. Log in with "admin" and the "new password" to access the Web interface.



Note

The following web screen is based on the IGS-4215-4P2T2S. The display of the other IGS-4215 PoE Series is the same as that of the IGS-4215-4P2T2S.



Figure 5-6: Web Main Screen of Industrial Managed PoE+ Switch

The Switch Menu on the left of the Web page lets you access all the commands and statistics the Industrial Managed PoE+ Switch provides.



Figure 5-7: Switch Menu

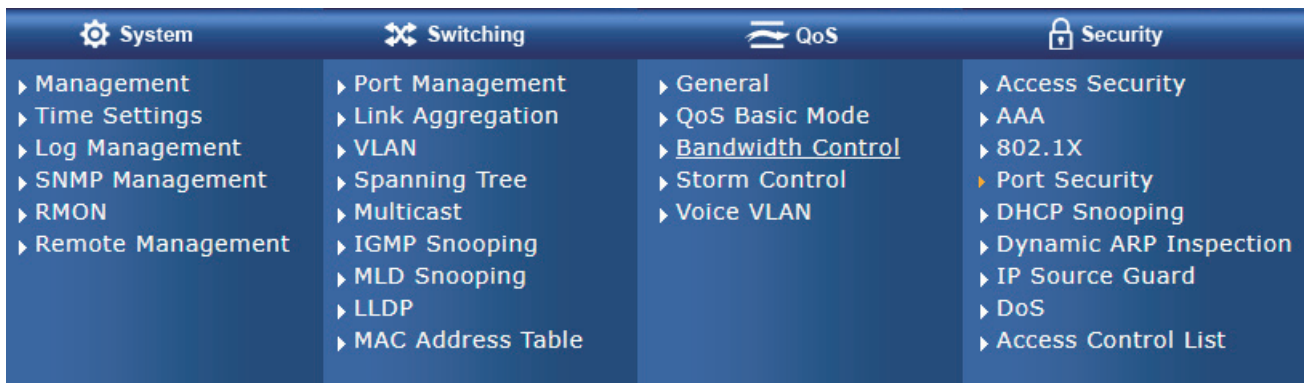

Figure 5-8: Switch Sub-menu

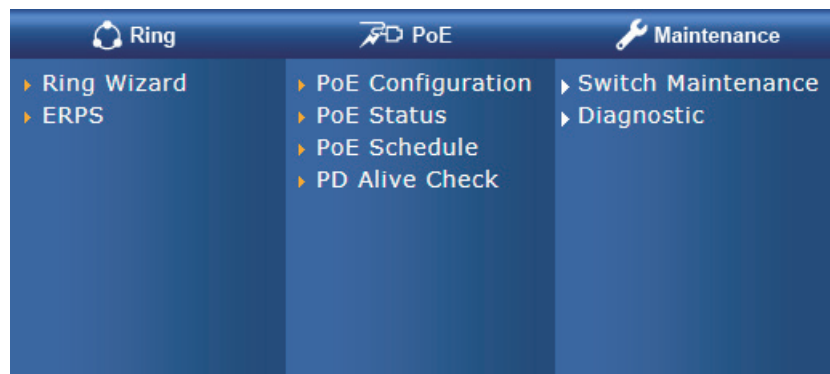

Figure 5-9: Switch Sub-menu

Now, you can use the Web management interface to continue the Switch management. Please refer to the user’s manual for more.

5.2 Saving Configuration via Web

To save all applied changes and set the current configuration as a startup configuration, the startup-configuration file will be loaded automatically across a system reboot.

1. Click the **Save** icon on the top Switch Menu bar.

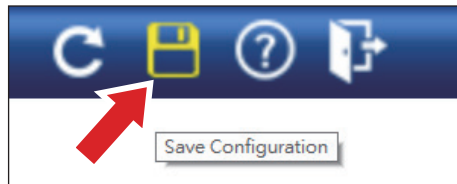

2. Press the **Apply** button to save running configuration to start up configuration.

Configuration Manager

Save Configuration

Source File	<input checked="" type="radio"/> Running configuration <input type="radio"/> Startup configuration <input type="radio"/> Backup configuration
Destination File	<input checked="" type="radio"/> Startup configuration <input type="radio"/> Backup configuration

Apply

6. Recovering Back to Default Configuration

■ IP Address has been changed or admin password has been forgotten –

To reset the IP address to the default IP Address “**192.168.0.100**” or reset the login password to default value, press the hardware-based **reset button** on the front panel for about **10 seconds**. After the device is rebooted, you can log in the management Web interface within the same subnet of 192.168.0.xx.

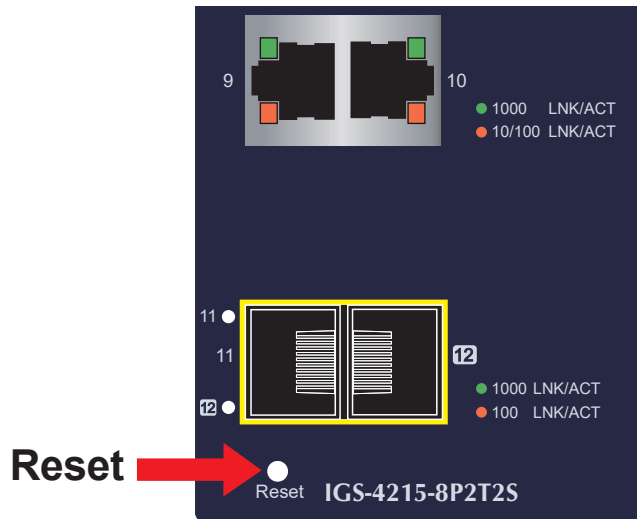

Figure 6-1: IGS-4215 PoE Series Reset Button

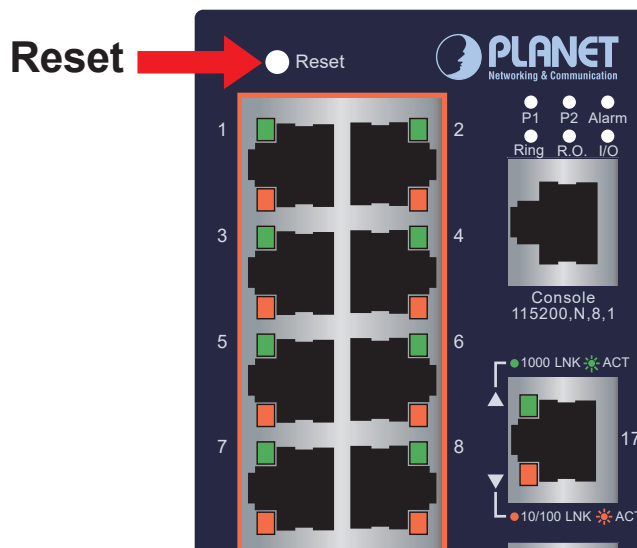

Figure 6-2: IGS-4215-16P2T2S Reset Button

7. Customer Support

Thank you for purchasing PLANET products. You can browse our online FAQ resource and User's Manual on PLANET Web site first to check if it could solve your issue. If you need more support information, please contact PLANET switch support team.

PLANET online FAQs:

<https://www.planet.com.tw/en/support/faq>

Switch support team mail address:

support@planet.com.tw

IGS-4215-4P4T/IGS-4215-4P4T2S/IGS-4215-8P2T2S/IGS-4215-16P2T2S/ IGS-4215-4UP4T2S/IGS-4215-8UP2T2S User's Manual:

<https://www.planet.com.tw/en/support/downloads?&method=keyword&keyword=igs-4215&view=3#list>



(Please select your switch model name from the Product Model drop-down menu)

Copyright © PLANET Technology Corp. 2024.

Contents are subject to revision without prior notice.

PLANET is a registered trademark of PLANET Technology Corp.

All other trademarks belong to their respective owners.